

Power Window <RHD>

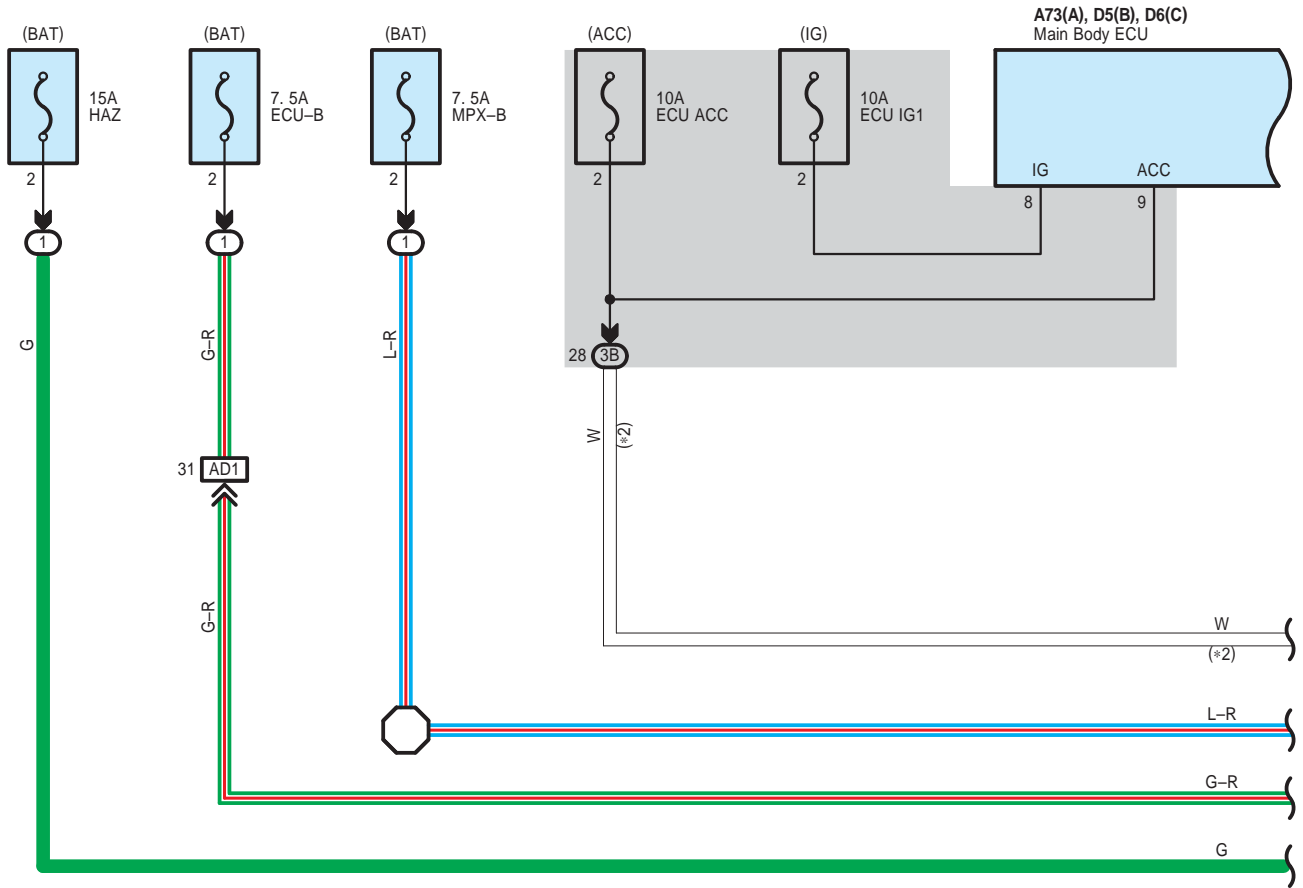

* 2 : w/ Entry & Start System

Power Window <RHD>

A73(A), D5(B), D6(C)
Main Body ECU

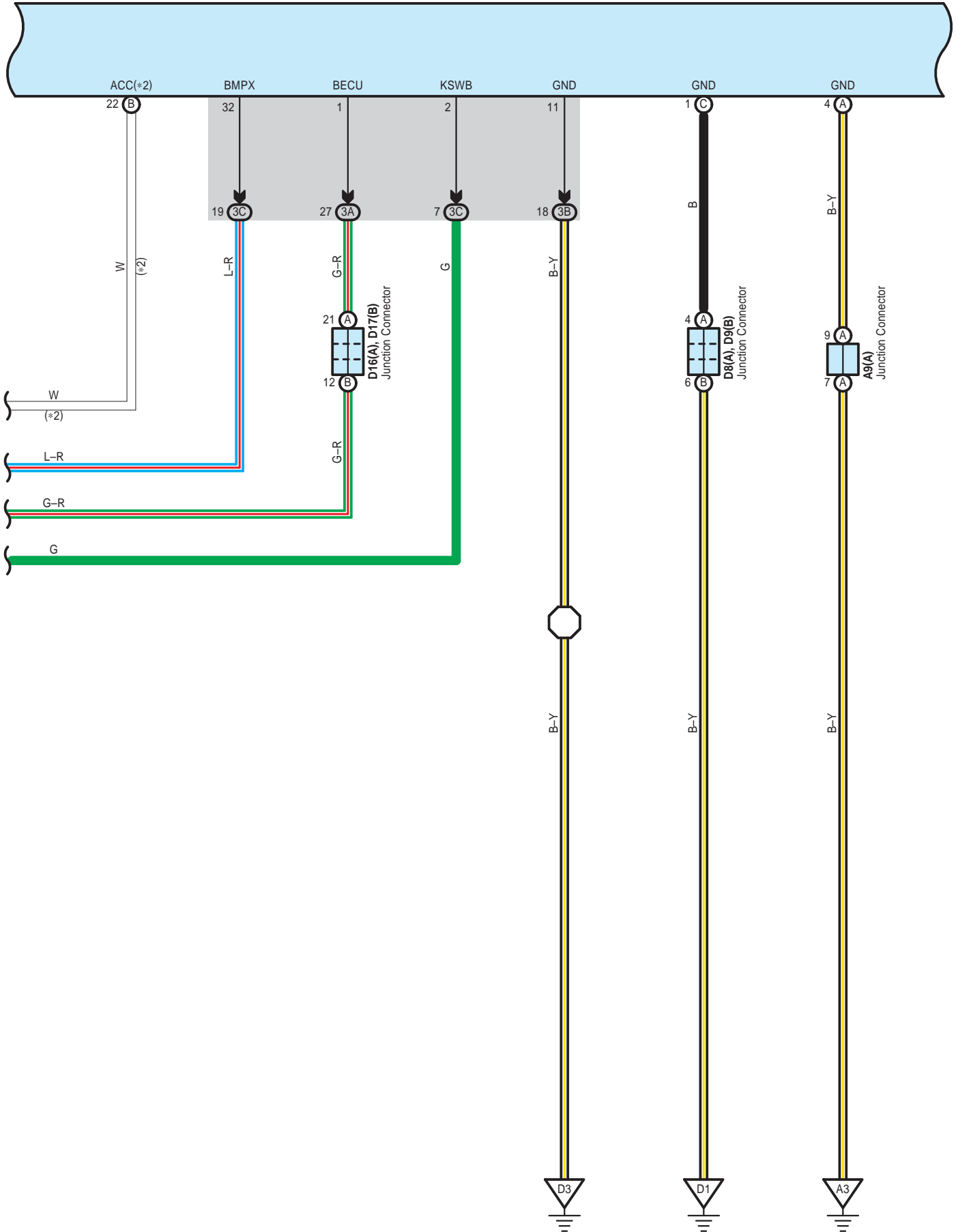

Power Window <RHD>

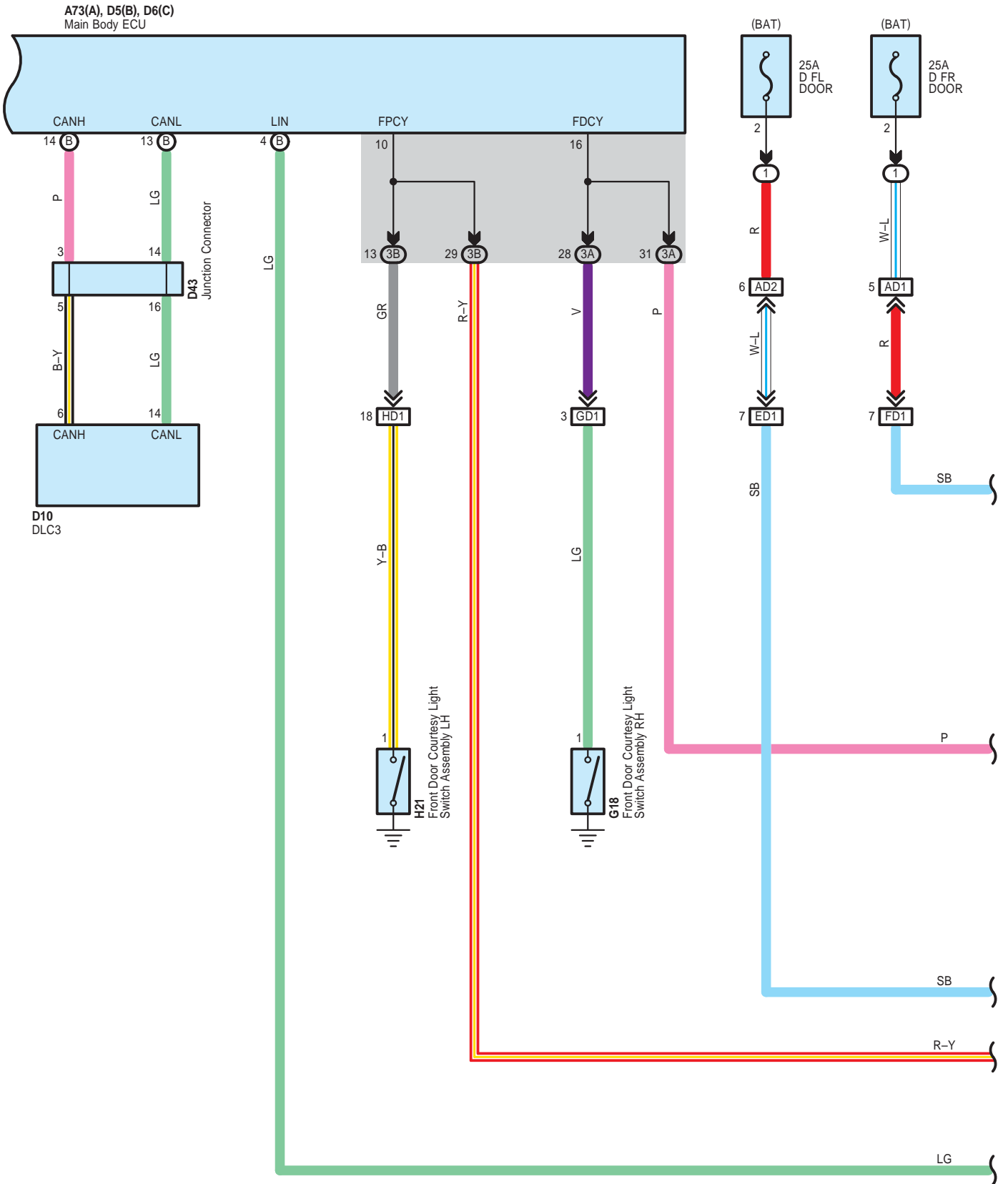

F10
Power Window Regulator Master Switch Assembly

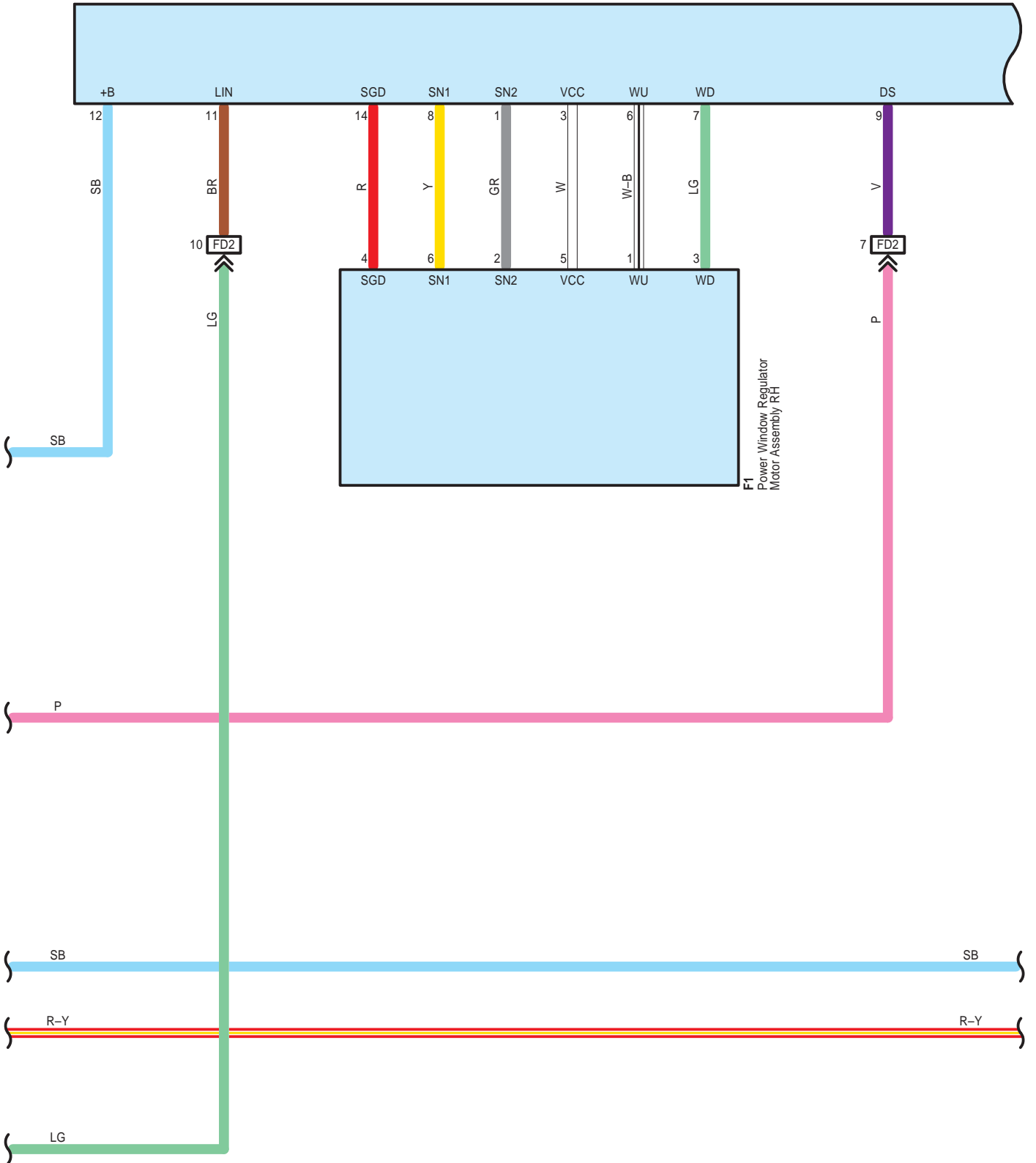

F10
Power Window Regulator Master Switch Assembly

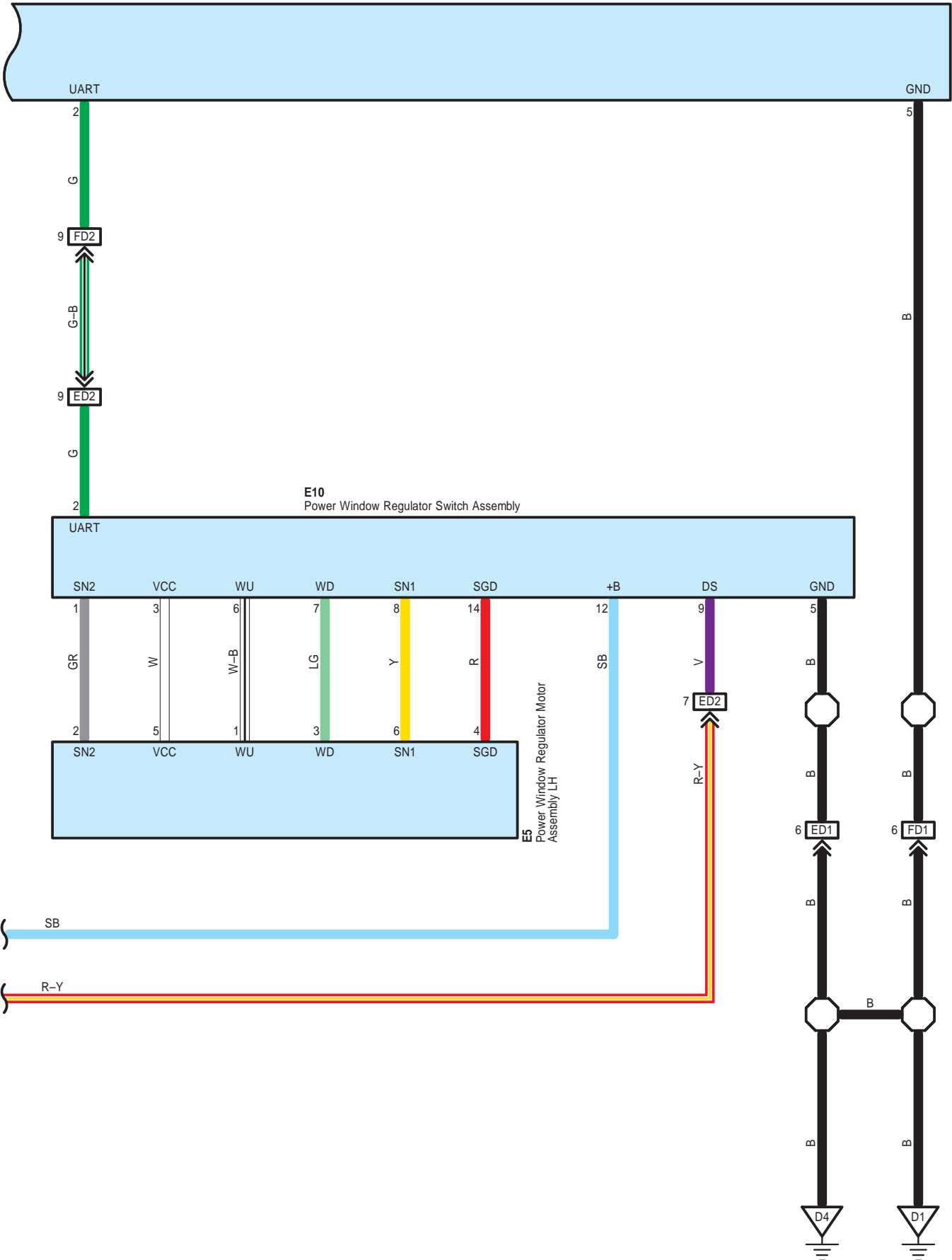

Power Window <RHD>

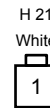
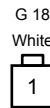
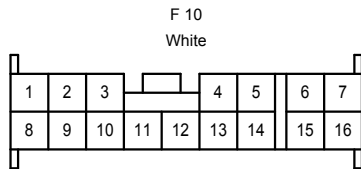
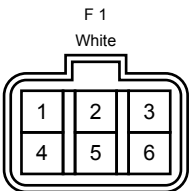
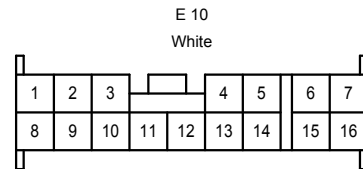
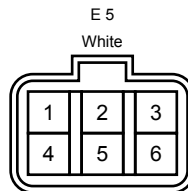
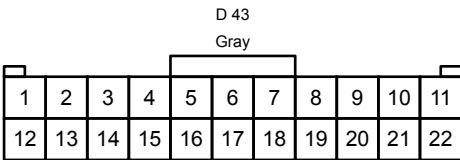
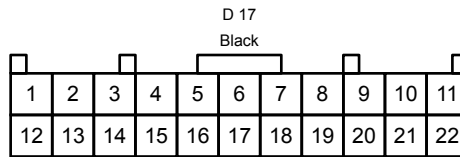
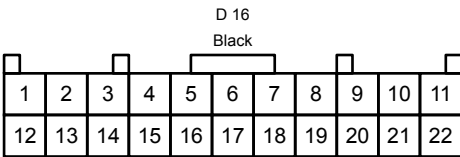
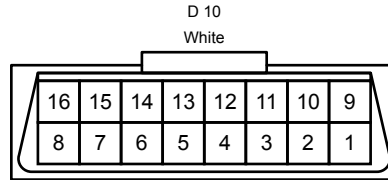
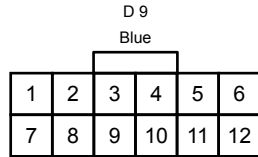
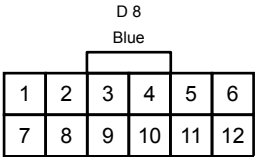
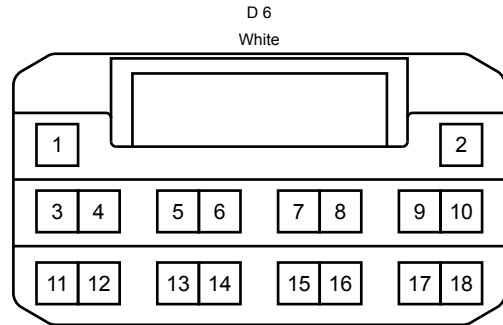
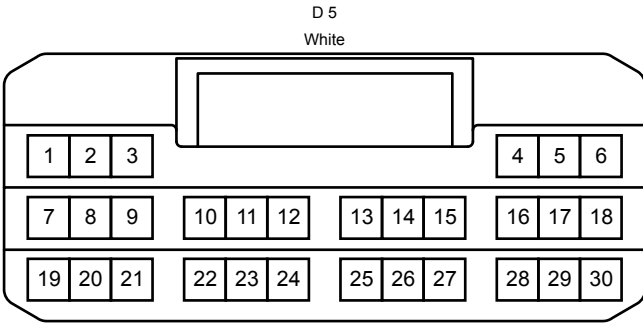
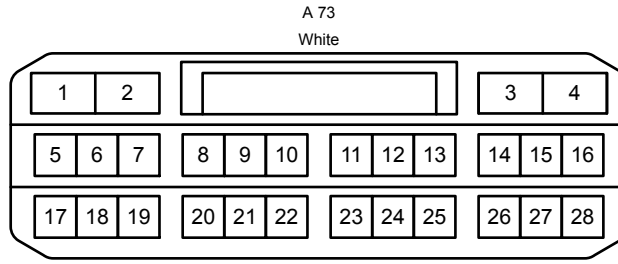
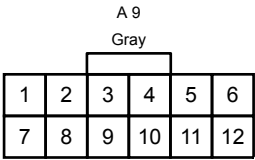

Power Window <RHD>

3A
White

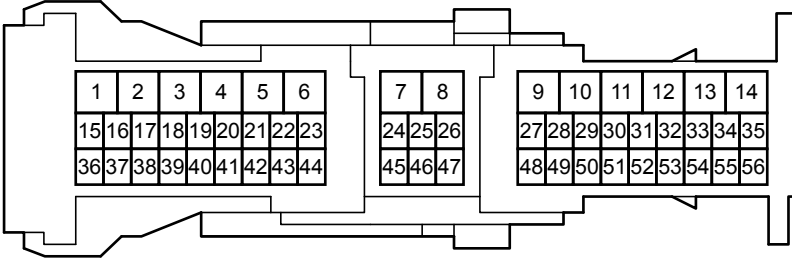

3B
White

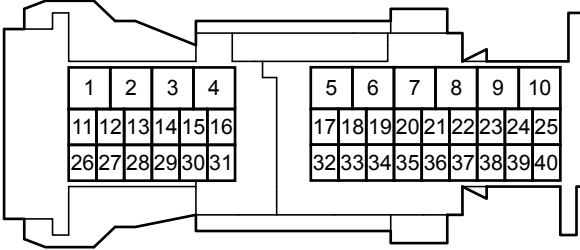

3C
White

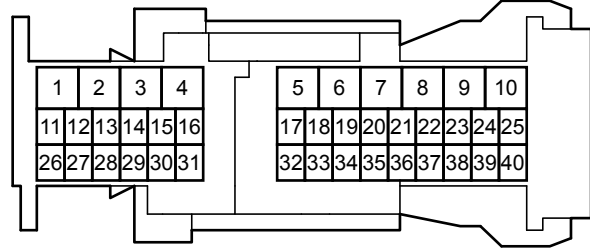

AD1
White

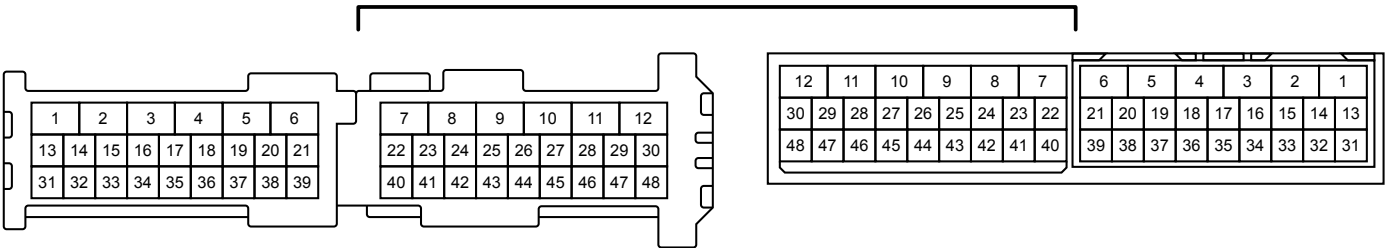

AD2
White

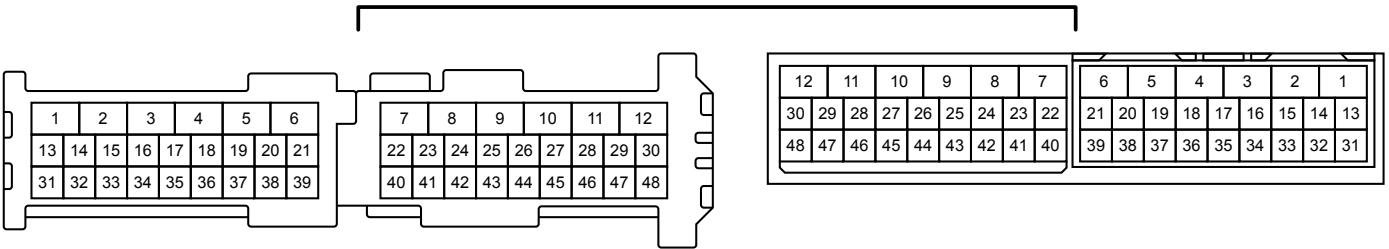

ED1
White

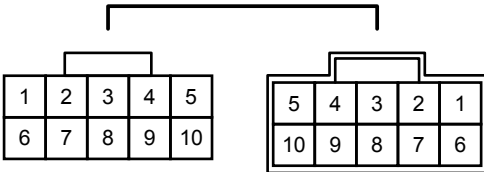

Power Window <RHD>

ED2

White

1	2	3	4	5	6	7	8	9	10	11
12	13	14	15	16	17	18	19	20	21	22

11	10	9	8	7	6	5	4	3	2	1
22	21	20	19	18	17	16	15	14	13	12

FD1

White

1	2	3	4	5
6	7	8	9	10

5	4	3	2	1
10	9	8	7	6

FD2

White

1	2	3	4	5	6	7	8	9	10	11
12	13	14	15	16	17	18	19	20	21	22

11	10	9	8	7	6	5	4	3	2	1
22	21	20	19	18	17	16	15	14	13	12

GD1

White

1	2	3	4	5	6	7
8	9	10	11	12	13	14

7	6	5	4	3	2	1
14	13	12	11	10	9	8

HD1

White

1	2	3	4	5	6			
13	14	15	16	17	18	19	20	21
31	32	33	34	35	36	37	38	39
7	8	9	10	11	12			
22	23	24	25	26	27	28	29	30
40	41	42	43	44	45	46	47	48

12	11	10	9	8	7			
30	29	28	27	26	25	24	23	22
48	47	46	45	44	43	42	41	40
6	5	4	3	2	1			
21	20	19	18	17	16	15	14	13
39	38	37	36	35	34	33	32	31